

SZAKSZERŰ FELÚJÍTÁS KNAUF RENDSZEREKKEL

KNAUF SZÁRAZÉPÍTÉS

Wiesner György

2024. május 16.



Meglévő tér – új funkció

KNAUF



Meglévő funkció – új forma Danoline TECTOPANEL rendszer

KNAUF

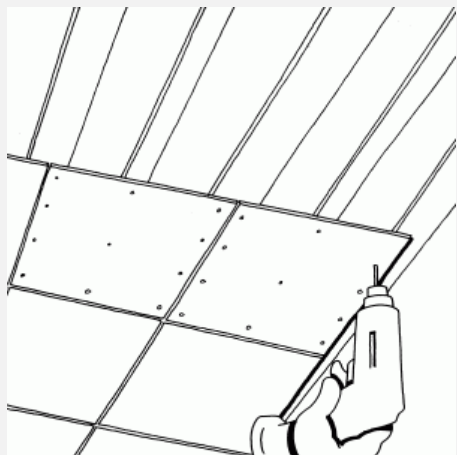

	Regula, Globe, Quadril, Micro
méret	12.5 x 300 x 1200 12.5 x 600 x 600 12.5 x 600 x 1200 12.5 x 600 x 2400

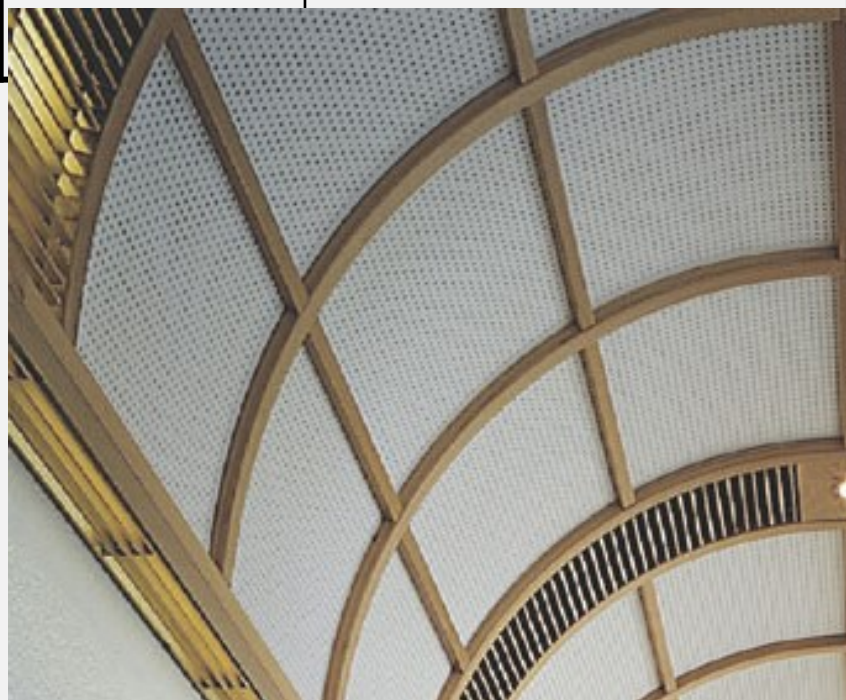
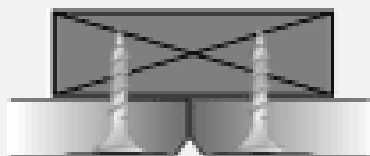

Szállóépület

Étterem

Kiállítás

Jóléti létesítmények



Vadászati kiállítás – magtárból

Szárzaljzat

- Vidifloor / Brio szárzaljzat

Tetőtér tűzvédelmi

- extra tűzvédelmi kialakítás

Statikai megerősítések

- Fireboard tűzvédelmi borítás

Szerelt homlokzat -

- Aquapanel / VidiFire rendszerek



Vadászati kiállítás – magtárból



Vadászati kiállítás – magtárból

KNAUF



Knauf Vidifloor F135 szárazaljzat

KNAUF

**Két réteg 1500 x 1000 mm-es
helyszínen egymáshoz ragasztva**

Lemezvastagság: 10/12,5 mm

Rétegvastagság: 20/25 mm

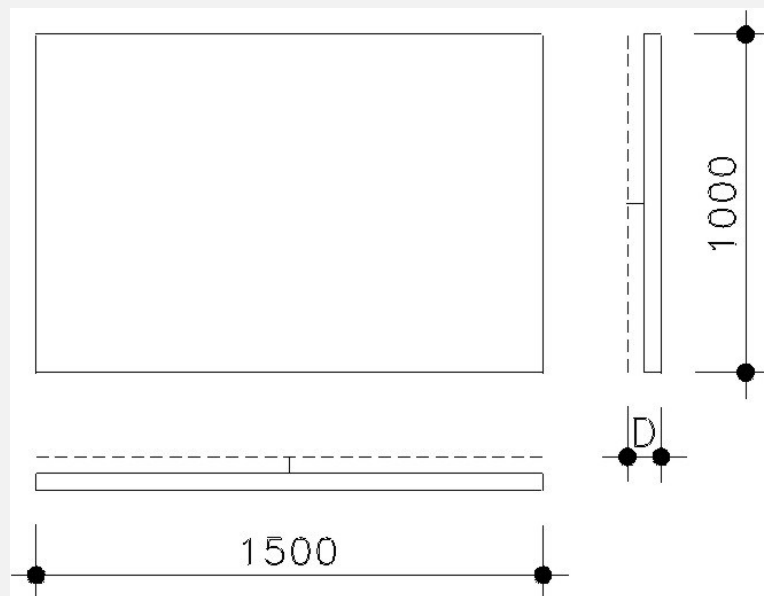

Knauf Vidifloor F135 szárazaljzat



Fafödémén, beton födémén

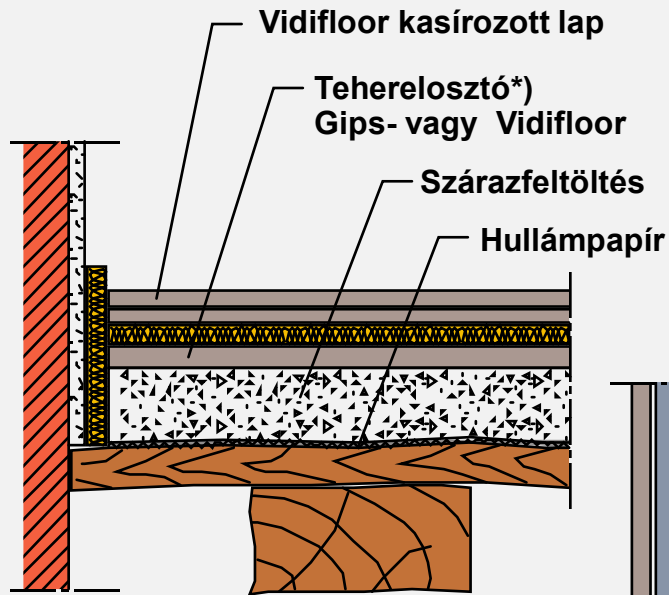

Szárazaljzat szárzfeltöltésen

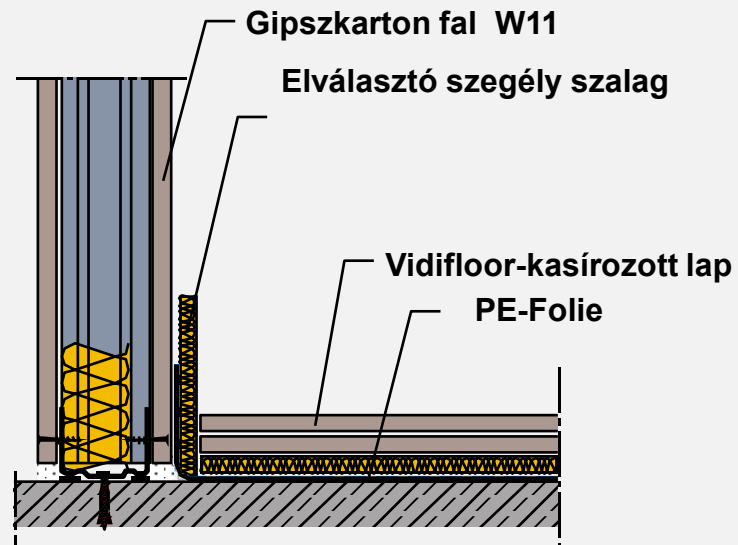

Knauf Vidifloor szárazaljzat

KNAUF

Szárazaljzat - Vidifloor szárazaljzat

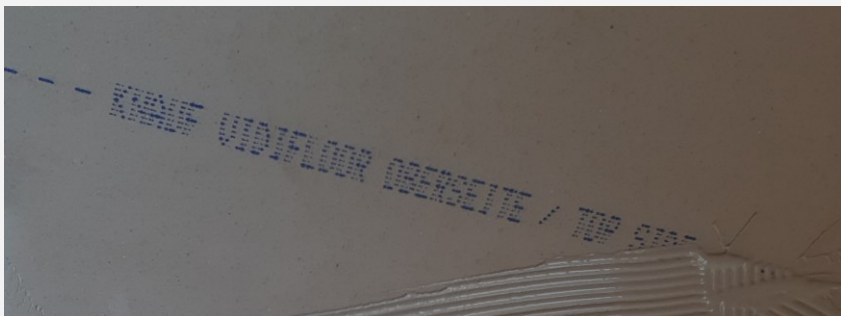

Szárazaljzat - Vidifloor szárazaljzat



Knauf Brio szárazaljzat



Szárazaljzat egy rétegben - Brio 18 vagy 23 mm-ben

Brio 18

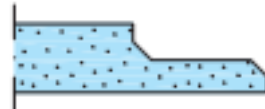

Brio 23

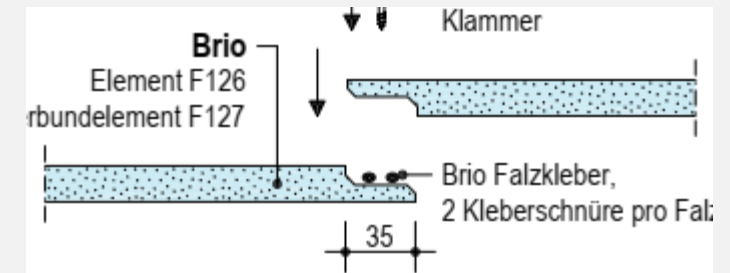
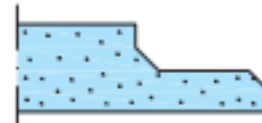

KNAUF BRIO



Knauf Brio szárzaljzat

KNAUF

Szárzaljzat egy rétegben - Brio 18 vagy 23 mm-ben

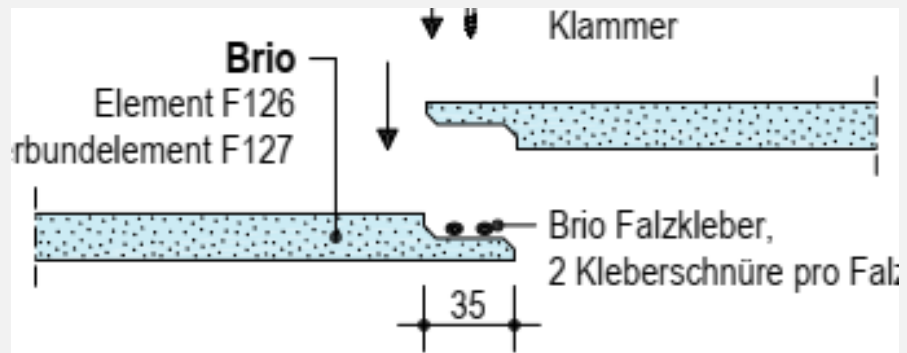

Terhelés szerinti választás:

- 2 kN/m²
- 3 kN/m²
- 4 kN/m²
- 5 kN/m²

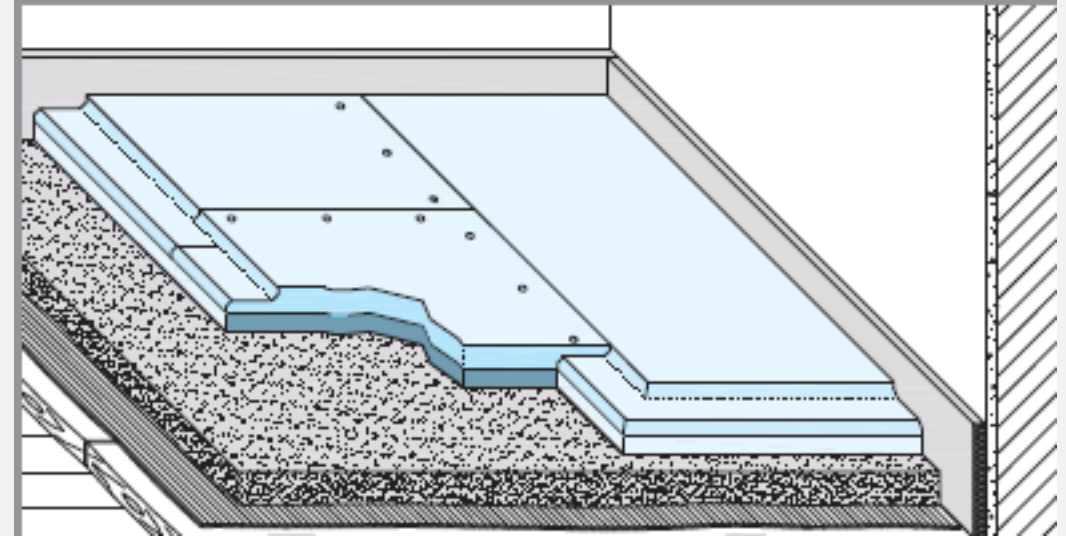
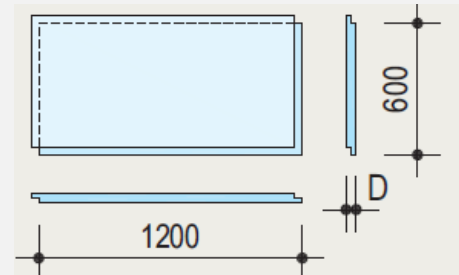

Méret szerint:

- 330/330 mm-ig – vastagság legfeljebb 9 mm
- 600/600 mm-ig – vastagság legfeljebb 10 mm
- 1200/1200 mm-ig – vastagság legfeljebb 20 mm

Knauf Brio szárzaljzat - 2 kN/m² terhelésig



Szárzaljzat

Burkolat

Brio 18 vagy 23

33 cm hidegburkolat méretig

Brio 23

60 cm hidegburkolat / 40 cm kőburkolat méretig

Brio 18 + 18

60 cm hidegburkolat / 40 cm kőburkolat méretig
padlófűtéssel

100 cm hidegburkolat / 60 cm kőburkolat méretig

Brio 23 + 23

100 cm hidegburkolat / 60 cm kőburkolat méretig
padlófűtéssel

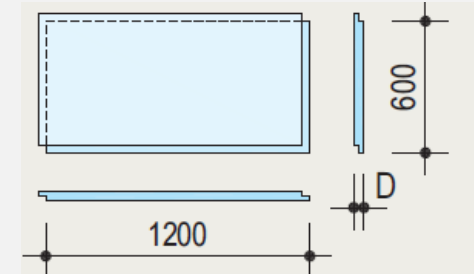

Kettős belső borítás

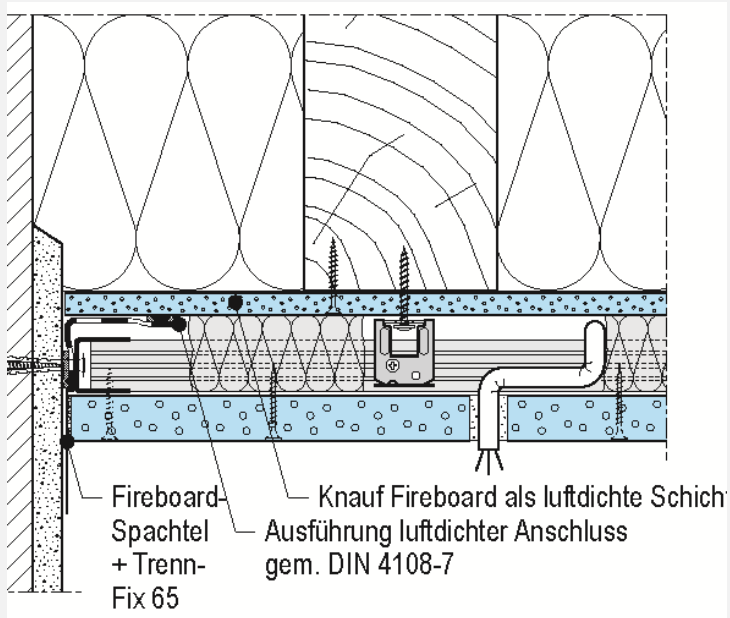

Knauf D61 tetőtérbeépítés

Mastertitelformat bearbeiten

Kettős belső borítás

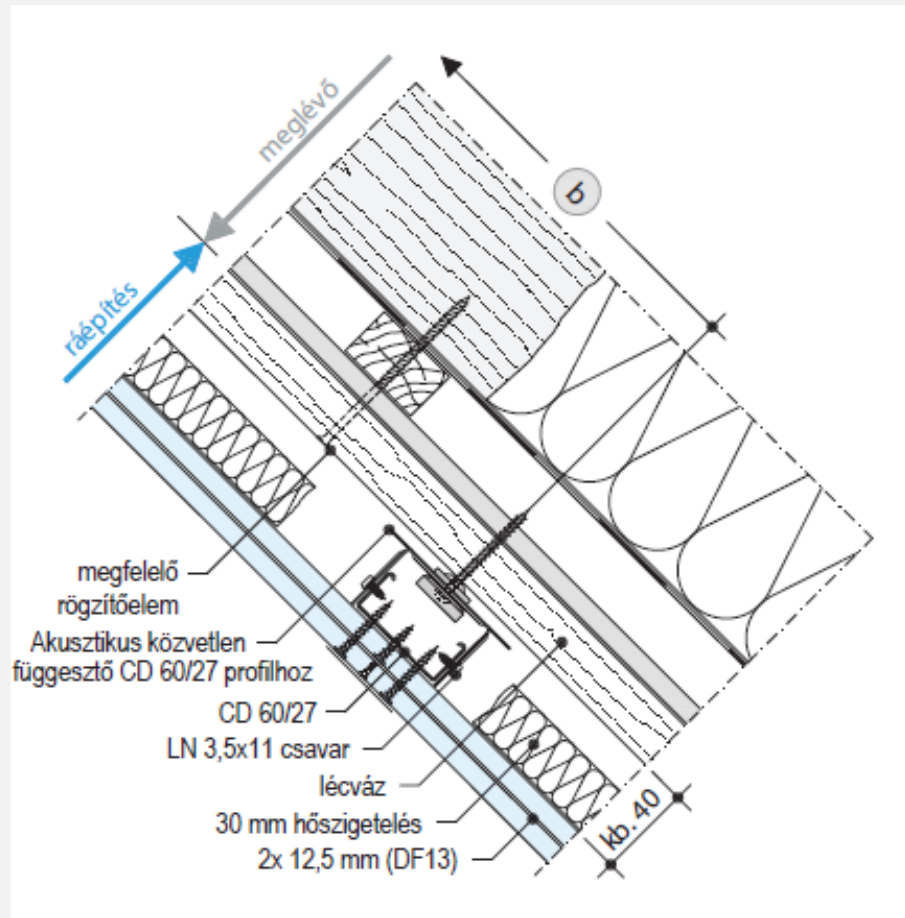

Falcsatlakozás

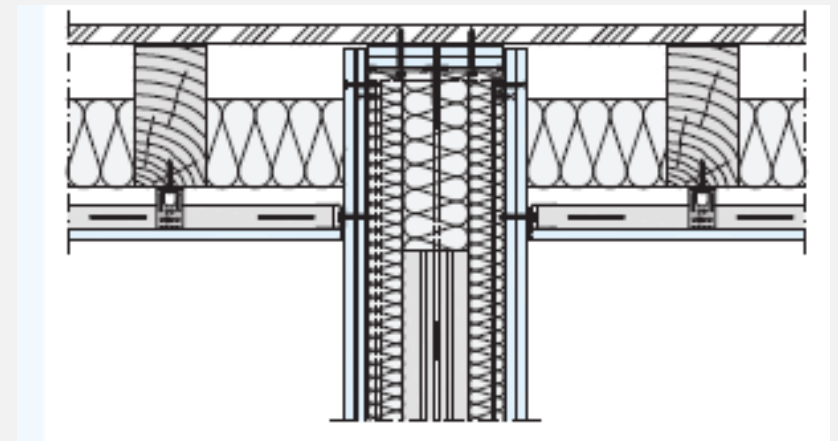
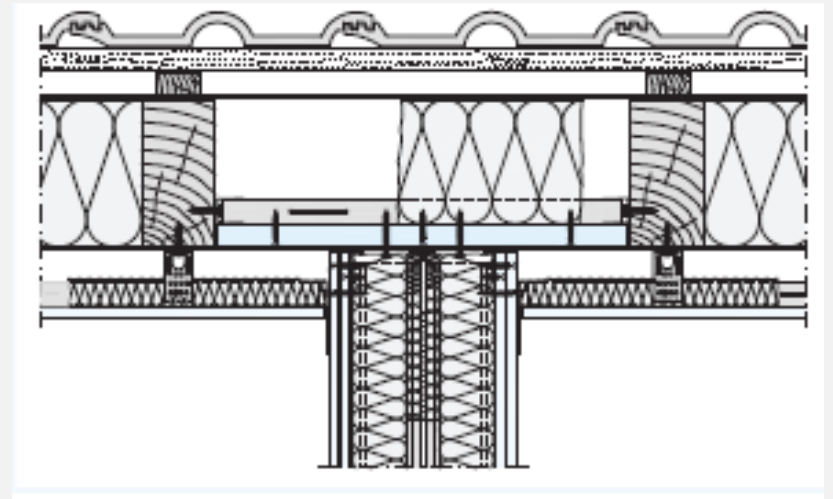

Knauf Fireboard tűzvédelmi borítás

KNAUF

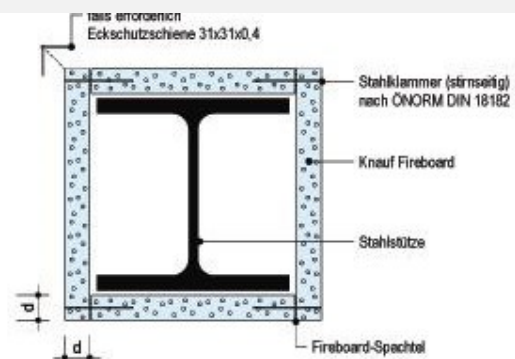

K253-H3 Horizontalschnitt - Einlagig beplankt

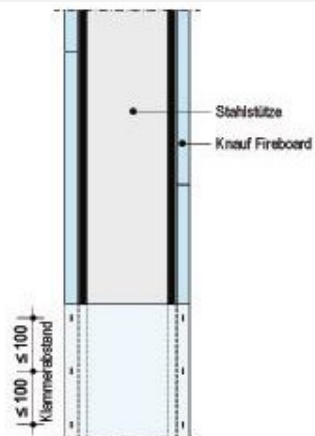
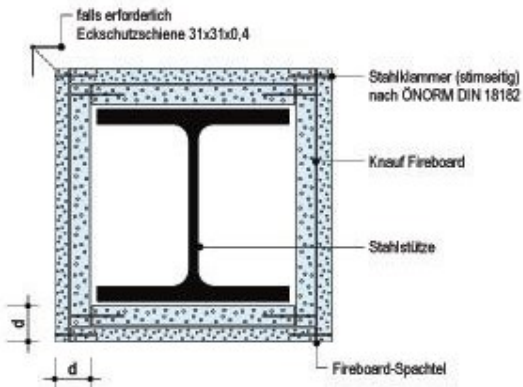

• zweilagig beplankt

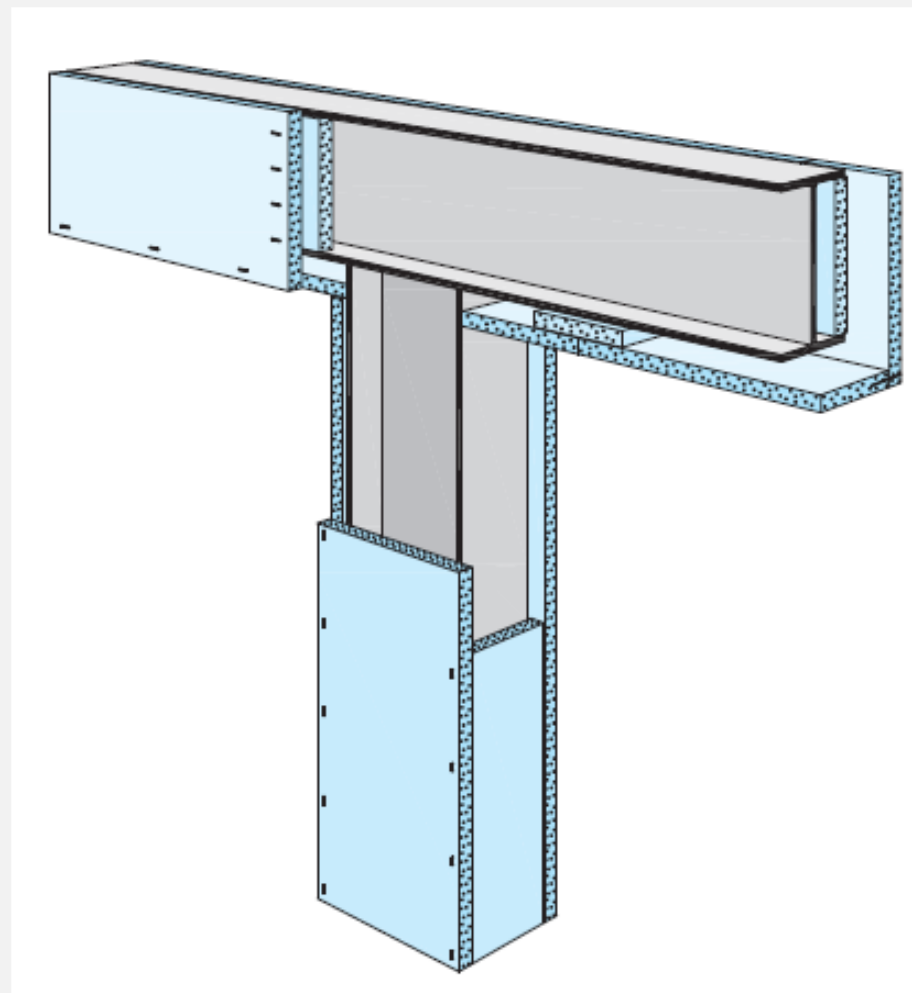
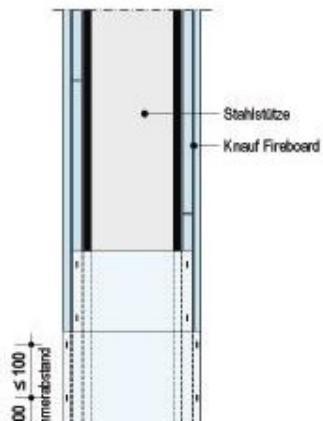

Knauf Fireboard tűzvédelmi borítás

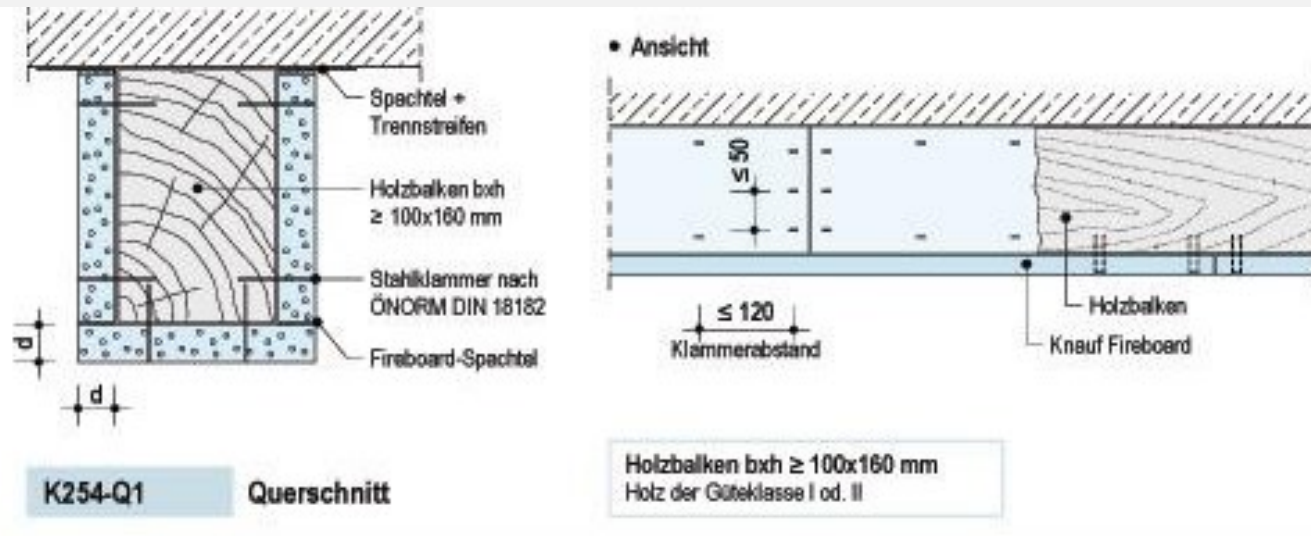

K255 Holzstützen-Bekleidung

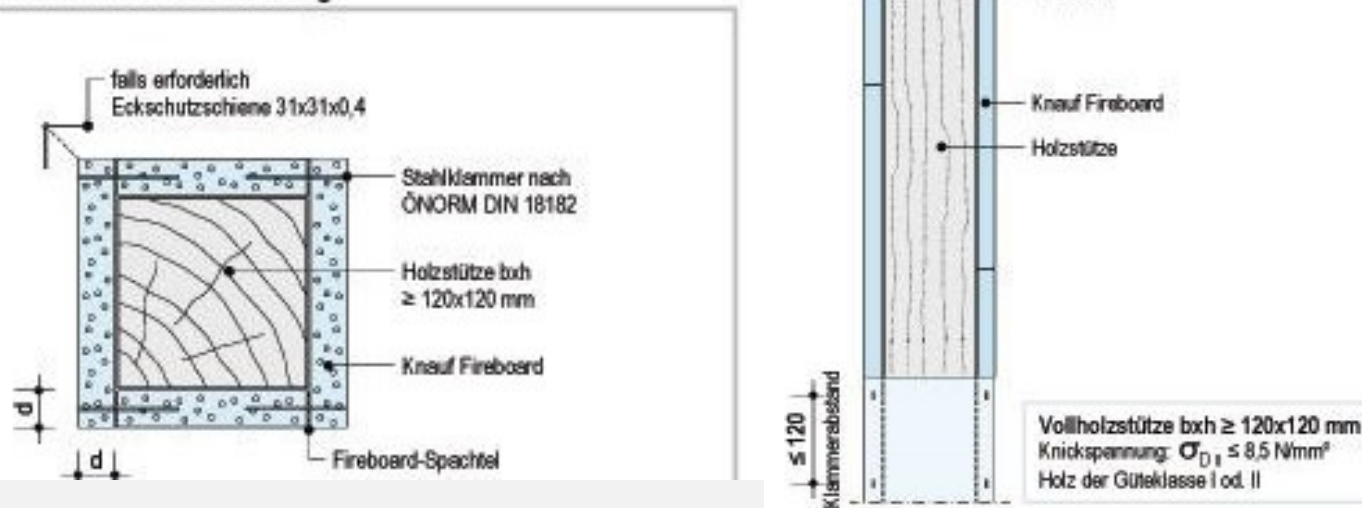



KNAUF

KÖSZÖNÖM A FIGYELMET!

Wiesner György
Knauf kft – műszaki vezető
gyorgy.wiesner@knauf.com